

Yhdc SCT-013-000 Current Transformer



**A Report
on the properties of the
Yhdc Current Transformer
and
its suitability for use with the
OpenEnergy monitor.**

by
Robert Wall B.Sc., C.Eng., MIEE.

Issue 6
18 March, 2014

Synopsis

The Yhdc current transformer is manufactured by Beijing YaoHuadechang Electronic Co., Ltd and factored by Seeed Studio of Shenzhen, China (www.seeedstudio.com) as Non-invasive AC current sensor (100A max), Model SCT-013-000, SKU THM105C4B.

It has no internal burden resistor, but zener diodes limit the output voltage in the event of accidental disconnection from the burden. It is capable of developing sufficient voltage to fully drive a 5 V input.

Test Rig

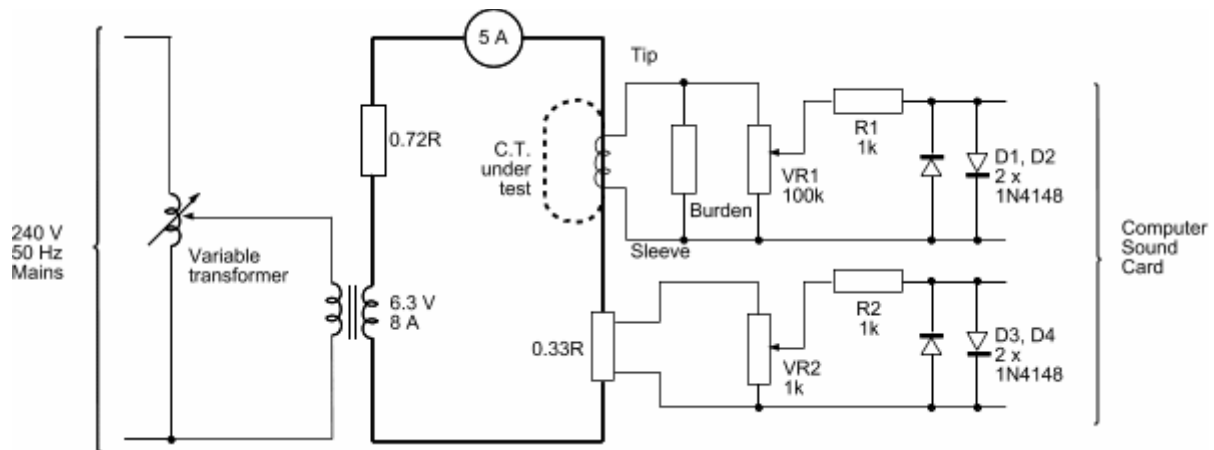

For test currents up to 150 A, the CT primary consists of from 1 to 30 passes of insulated 16/0.2mm wire, and the majority of tests were made at 5 A – thus the primary current seen by the CT could be adjusted in steps of 5 A by enclosing a variable number of turns inside the core. For saturation tests up to 250 A, the primary consists of 50 passes of enamelled copper wire, the current being adjusted in this case.

(Note: The current exceeds the rating of the wire used for the primary, but as the coil is loosely bunched except where it passes through the transformer core, and because each test is of relatively short duration, heating is not a problem).

The primary current was monitored by the 0.33Ω shunt. The potentiometers, current limiting resistor and diodes in both the shunt and the CT outputs are to protect the computer sound card from over-voltage and switching transients, the potentiometers were adjusted such that the voltage did not exceed 400 mV peak and at this voltage, the diodes did not affect the shape of the monitored waveform.

When the shape of the waveform was of interest, the primary current and CT voltage waveform were recorded using a software oscilloscope (Soundcard Oscilloscope from http://www.zeitnitz.de/Christian/scope_en) and the recorded waveform imported into a spreadsheet and subsequently calibrated against the actual voltage read either by a multimeter or a real oscilloscope connected directly across the CT output.

Since first compiling this report in early 2012, YHDC appears to have changed the core material of the transformer, and a more sensitive and hopefully more accurate technique for measuring the phase error has been developed. For this issue, the two original samples of current transformer have been measured again, and results of phase measurements from a third sample taken from a recent batch have been added.

The Yhdc Current Transformer

Internal Components.

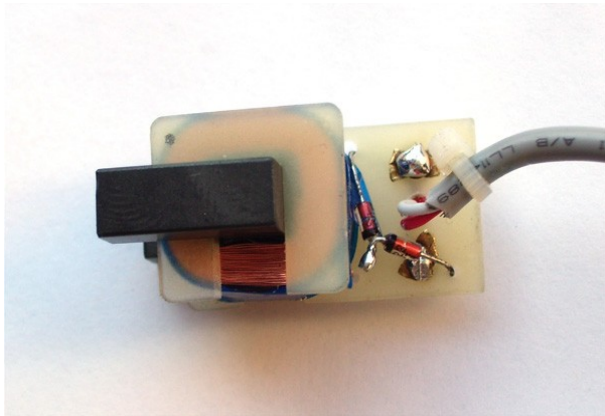

(Early model with wire-ended diodes)

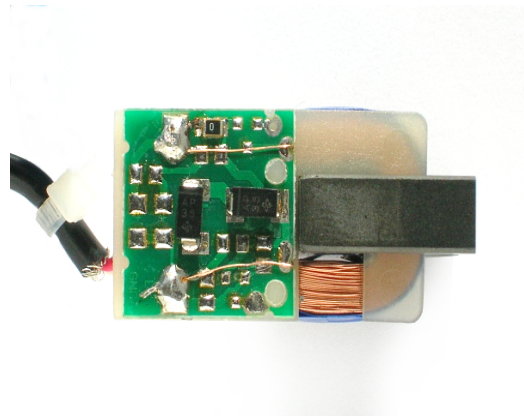

(Recent version with SMT parts)

Circuit Diagram.

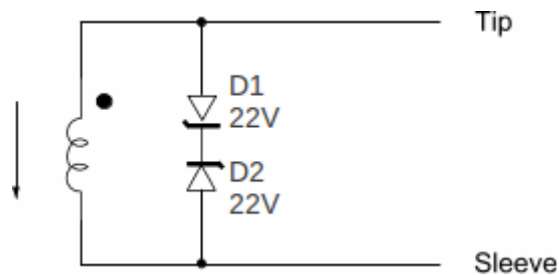

The current arrow represents current flowing out of the face of the transformer labelled “SCT-013-000”, then the plug tip is positive with respect to the sleeve.

The ring of the plug is not connected.

The purpose of the two 22 V zener diodes is to limit the voltage that may appear on the plug and across the windings to a safe value should the transformer be unplugged from the transmitter/instrument and the burden whilst the primary is energised.

Note: The output of the recent versions is clipped at ± 7.5 V. In the absence of a burden resistor, recovery from clipping is accompanied by H.F. ringing.

Tests

The following tests were conducted:

1. Check the ratio
2. Establish the useful range
3. Establish the effect of burden resistance
4. Establish the phase error
5. Establish the frequency response
6. Check operation with no external burden
7. Establish the maximum output when saturated

8. Establish the effect of an air gap.
9. Establish the effect of an adjacent current-carrying conductor.

1. Ratio.

Two samples of the CT were checked at steps of 10 A up to 100 A. The secondary current was measured with a digital multimeter.

Primary Turns (Amps per turn = 5.04)	Primary Current (A)	Measure d Sec current (No.1) (mA)	Measure d Sec current (No.2) (mA)	Design Sec current (mA)	Error (No.1) (%)	Error (No.2) (%)
0	0	0	0	0	0	0
2	10.08	4.98	4.88	5.04	-1.19	-3.17%
4	20.16	9.87	9.91	10.08	-1.09%	-1.69%
6	30.24	15.00	14.85	15.12	-0.79	-1.79
8	40.32	19.87	19.94	20.16	-1.44	-1.09
10	50.40	24.8	24.8	25.2	-1.59	-1.59
12	60.48	29.9	29.5	30.24	-1.12	-2.45
14	70.56	35.0	34.9	35.28	-0.79	-1.08
16	80.64	40.1	39.5	40.32	-0.55	-2.03
18	90.72	45.0	44.9	45.36	-0.79	-1.01
20	100.8	49.4	49.8	50.40	-1.98	-1.19

Secondary current against primary current

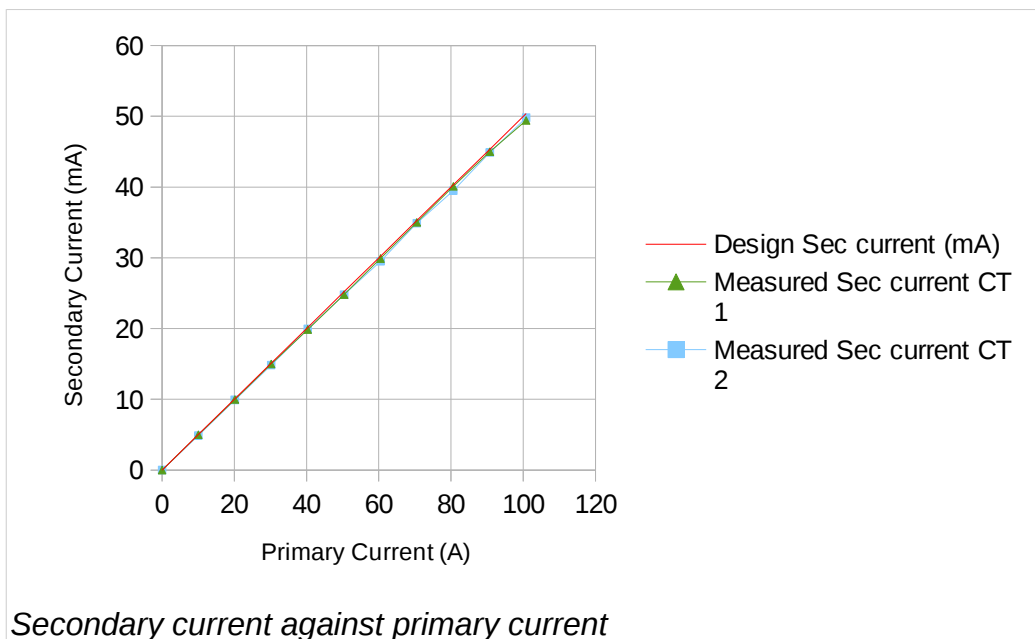

Secondary current against primary current

The mean ratio over the range 0 – 100 A is 2025. On the Yhdc data sheet the ratio is stated as 100 A : 50 mA (2000) and the measured value agrees with this to well within the

limits of uncertainty in the measurement. A unit from an earlier batch was measured at 1854, which is not within the tolerance that should be expected. The value of 100 A : 33 mA (3030) on the Seedstudio website is clearly an error.

Measurement errors.

The primary current was set on a moving iron ammeter that had been checked against the multimeter. An indicated 5 A measured 5.04 A and this error was accounted for in the measurements. Measuring 5 A, the multimeter used has an accuracy of $\pm(3\% + 10 \text{ digits})$, or 5%. On the mA ranges used to measure the secondary current, the accuracy is $\pm(1.5\% + 5 \text{ digits})$, or between 2.4% and 3.2% depending on the reading. Therefore the total uncertainty in the ratio measurement is around 7.5 – 8.5%.

2. Useful Range.

Saturation is just starting at 100 A, therefore this confirms the maximum current rating. However, the transformer will still give reasonably accurate results even when subjected to a moderate overload.

3. Effect of burden resistance.

As the burden resistance is increased, an increased voltage will be developed across the burden and eventually the output waveform becomes distorted as the core saturates. The variable transformer introduced a flattening of the peak of the current waveform, giving a residual distortion of 2.5%. The value of resistance to give 5% total distortion (at which point the distortion was starting to increase noticeably with increasing resistance), and the voltage at which this occurred, was measured.

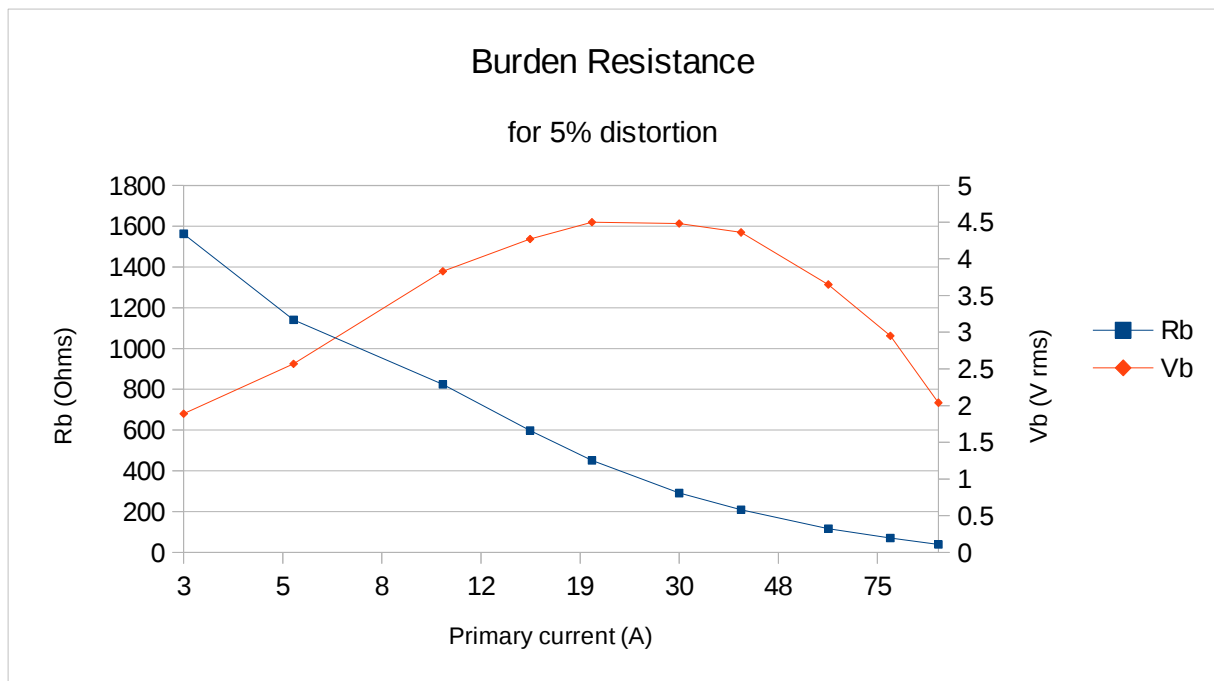

Effect of burden resistance

At any maximum current (> 5 A), the resistance at which 5% total distortion occurred was greater than the value necessary to give 5 V peak-peak across the burden resistor, hence saturation poses no limit to the choice of value for the burden resistor.

4. Phase error.

The phase error was measured for 2 values of burden resistor. The values chosen were 18 Ω , the value used in the emonTx Version 2, and 120 Ω which is the value used for the high sensitivity input of the emonTx Version 3.

No.1 & No.2 are the two measured earlier, and No.3 is from a recent batch. No.3 shows a noticeably smaller error that also varies less with current for both burden values. But a note of caution is due with regard to the values at and below 100 mA primary current where noise and pickup were interfering with the measurements, and these cannot therefore be regarded as reliable.

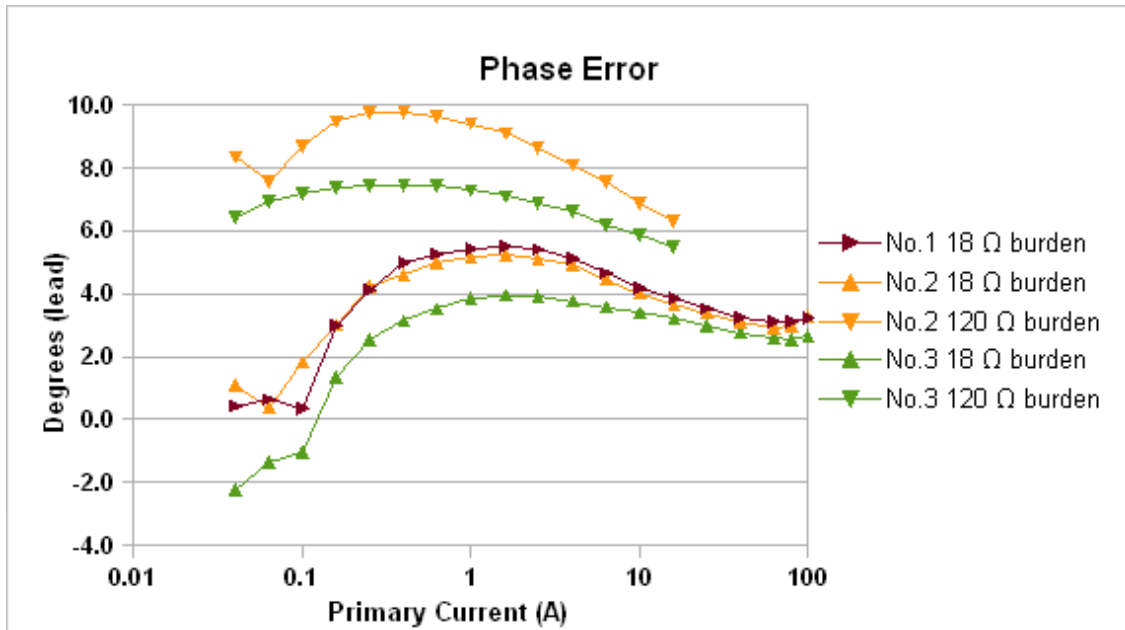

5. Frequency Response.

The frequency response was checked at a primary current of 30 A and a burden resistance of 39 Ohms. The phase error remained below 1 degree and amplitude error remained below 1% up to the 13th harmonic of line frequency (650 Hz). At 1.5 kHz the amplitude error remained below 1% whilst the phase error had increased to 5 degrees. At 2.5 kHz the amplitude error had risen to 3% whilst the phase error had increased to 10 degrees. These errors are insignificant.

6. Operation without an external burden.

When operated without an external burden, the core quickly saturates. The protective zener diodes conduct at 22 V and this corresponds to a primary current of about 18.3 A.

The diodes are not intended to nor will they protect the input circuitry of the Arduino processor and this voltage would without doubt seriously damage or destroy the Arduino chip.

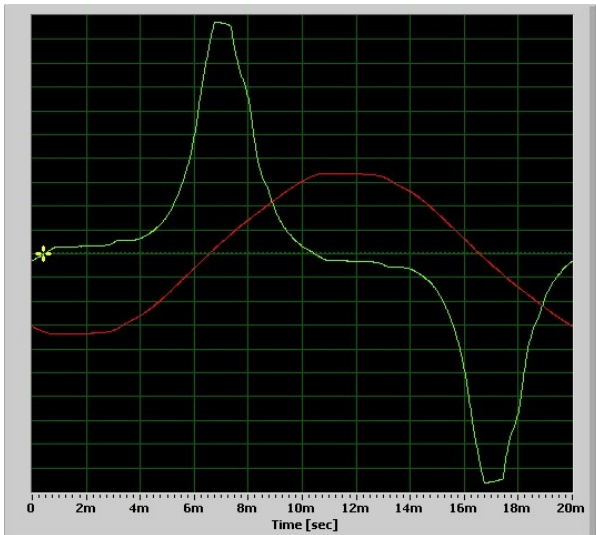

(The green trace is voltage, the red trace is current, the flattening is caused by large numbers of rectifier loads. Note: the vertical scale is uncalibrated).

7. Maximum output in saturation.

In order to determine the effect of a fault in the primary circuit downstream of the CT, the transformer was driven well into saturation and the output current recorded.

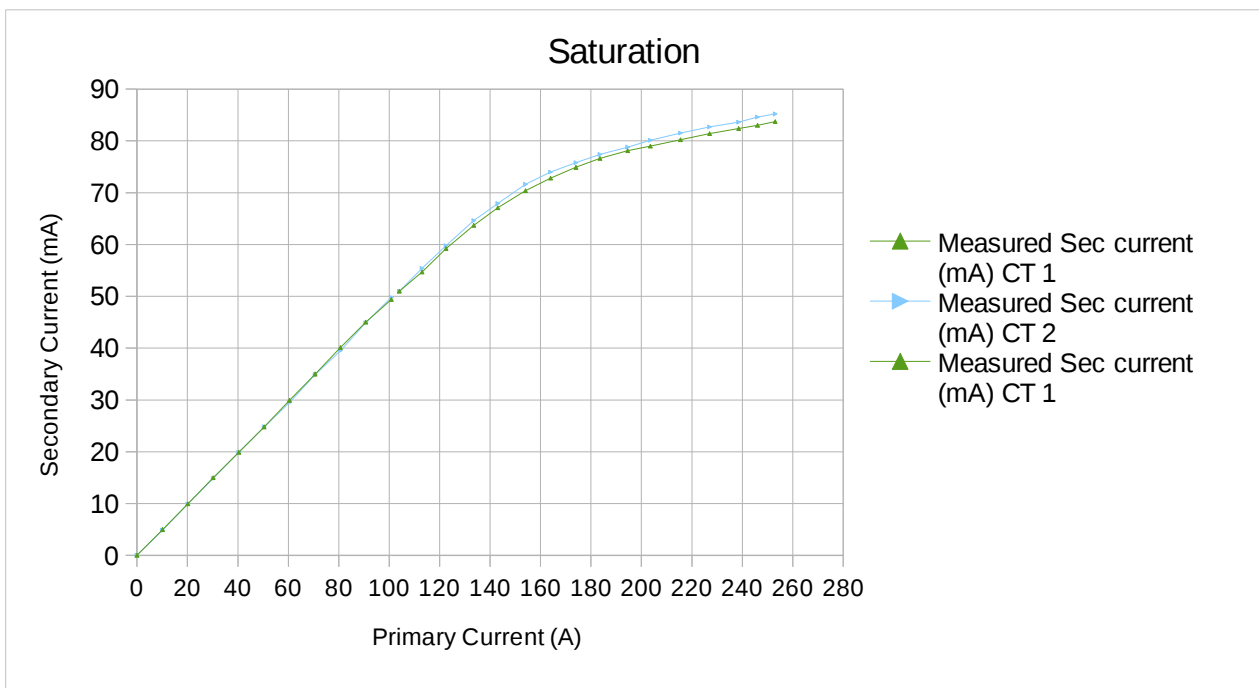

The secondary current waveform suffered increasing distortion above 100 A (as would be expected) and the values of secondary current in the graph above are rectified average value scaled to rms.

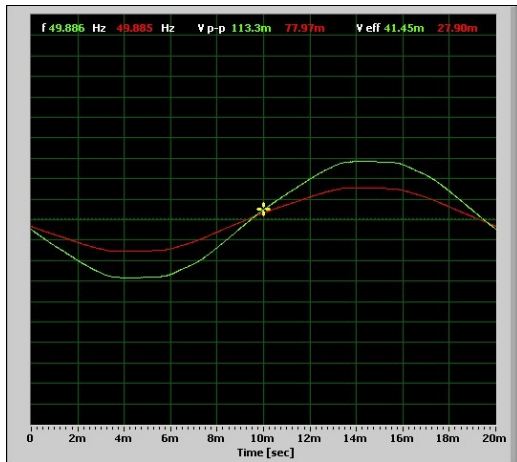

15 Ω burden, 100 A

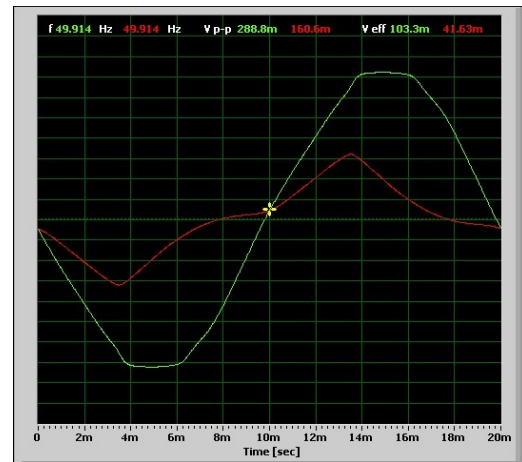

15 Ω burden, 250 A

(The primary current is the green trace, burden voltage is the red trace. The burden voltage at 250 A is 5.2 V p-p)

8. Effect of an air gap.

Introducing an air gap of 0.1 mm in one side of the core caused the secondary current to fall by 7%.

9. Effect of an adjacent current-carrying conductor.

To measure this, a large coil of 20 turns carrying 5 A, oriented so as to simulate a parallel conductor carrying 100 A, was used. The current transformer under test was outside the coil. The equivalent current is the current that the CT would have measured in a conductor passing through the CT.

Distance	Equivalent Current
Touching	160 mA
20 mm	110 mA
50 mm	44 mA
100 mm	15 mA

Conclusions

The Yhdc current transformer is suitable for use with the OpenEnergy emonTx. It can develop sufficient voltage to fully utilise the resolution of the Arduino's analogue input, and waveform distortion due to saturation at this secondary voltage is negligible for normal purposes. The maximum phase error of 4° from the latest batch with the 18 Ω burden is insignificant (representing a power factor error of less than 0.0025 at unity power factor), but the error of nearly 10° with a 120 Ω burden could be troublesome with low current loads having a poor power factor where this input is most likely to be used.

Changes

Issue 1. 3rd February, 2012

Issue 2. Frequency Response added, 12th February, 2012.

Issue 3. Ratio & saturation data was from one early sample CT, max output in saturation, air gap & appendix added, 23rd February, 2012

Issue 4. New graph for Phase Error (using new batch CT). 3rd March 2012.

Issue 5. New graph for Phase Error and latest batch CT No.3 added. 21st December 2013.

Issue 6. Measurements of effect of adjacent conductor added. 18th March 2014.

Appendix

Measurements on non-sinusoidal waveforms.

Most budget multimeters *measure* the rectified average value of an alternating wave, then the reading is scaled to *display* the root mean square (rms) value assuming the shape of the wave to be a sinusoid. (The rms value is the value of a direct voltage or current that would give the same heating effect in a purely resistive load).

For many purposes, this approach is entirely adequate, but where the wave shape departs from the sinusoid, this has to be taken into account. When the shape departs markedly from the sinusoid, the difference can be large.

The software oscilloscope used to capture the illustrations above has the capability to export the data points to a text file; that file can then be imported into a spreadsheet for processing. Taking that approach, these values were calculated for the “15 Ω burden, 250 A” waves:

Calculation	Current (divisions)	Burden Voltage (divisions)
Peak-peak	14.47	6.41
Rectified average (measured value)	4.62	1.30
Rectified average x 1.11 (displayed value)	5.13	1.45
rms	5.16	1.66

The multiplier 1.11 is the 'form factor' for a sine wave. The shape of the current wave is quite close to a sine wave, so the true rms value (5.16) is very close to the value that a budget meter would indicate (5.13 – reading 0.6% low). That is not true for the burden voltage – the meter would read 12.6% low.

The situation is even worse if the displayed value is used to calculate the peak-peak value. The true peak-peak burden voltage is 6.41. Taking the average voltage as measured with a budget meter, multiplied (internally) by 1.11, and then taking that displayed value (1.45) and multiplying by $2\sqrt{2}$ to give the peak-peak value assuming a sine wave gives the value of 4.10. The calculated value is low by 36%, a significant error. The form factor for the burden voltage wave turns out to be 1.28.

(Note that even a true rms meter will only calculate the correct value over a limited range of form factors).